

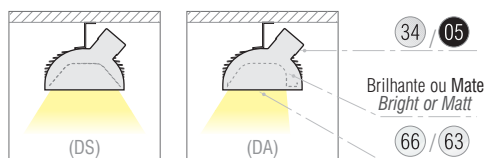

**descrição** description

- Aparelho em perfil de alumínio com grande flexibilidade de dimensões e potências, para aplicação saliente com versões com Iluminação Directa Simétrica (DS) ou Directa Assimétrica (DA); outras versões disponíveis para aplicação suspensa.
- O seu elevado rendimento luminoso, coloca este aparelho entre os mais indicados para aplicação suspensa entre os 5 e 8 metros de altura relativamente ao plano de trabalho.
- Equipada com difusor acrílico cristal (transparente) de elevada resistência ao impacto (IK06) e acabamento serigrafado, para aplicações em que se pretenda um rendimento luminoso superior.
- *Technological, unique design surface mounting luminaire with unique functional technical details showing the R&D work extent invested on this project; other versions available for suspended mounting.*
- *Extruded aluminium construction for suspension mounting available with Symmetric lighting (DS) or Asymmetric lighting (DA).*
- *Range of very versatile high performance luminaires for suspended use at high mounting heights in commercial and industrial interiors.*
- *Crystal clear with serigraphic design finishes IK06 impact resistant acrylic diffuser for improved performance.*



**pormenores** details



Sempre que o rendimento luminoso do aparelho seja um factor relevante, opta-se pela aplicação de um difusor acrílico cristal (transparente), de elevada resistência ao impacto (IK06) e acabamento serigrafado resistente ao desgaste.  
*Crystal clear with serigraphic design finishes IK06 impact resistant acrylic diffuser for areas requiring improved performance.*

**acabamento** finishing

- 34 Alumínio anodizado mate . *natural matt anodised aluminium*
- 05 Preto Mate RAL 9005 *Matt Black RAL 9005*

**diagr.polar** p.diagr.

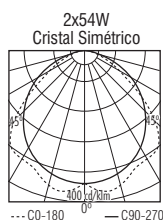

## simbologia symbols

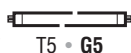

230V/50Hz EN 60 598



650°C

850°C

sob consulta

IK06

IP64



**reflectores** louvres · refl. alumínio Brilhante ou Mate · *Aluminium louvre Bright or Matt*

**difusores** diffuseurs · (66) Acrílico cristal · *Clear acrylic*  
 (63) Acrílico opal 030 · *Opal 030 Acrylic*

**extras** standard extras · **K** - Kit de Emergência de 1 ou 3 horas. *Fitted with 1 or 3 hours Emergency Kit.*

## opções options

**G** (HF) - Versão-base Balastro Electrónico. *Basic-version equipped with High Frequency Electronic Control Gear.*

**V** (DIM) - Balastro Electrónico que permite a Regulação do Fluxo Luminoso. *Equipped with High Frequency Electronic Dimming Control Gear.*

**Dali** (Digital Addressable Lighting Interface) - Sistema de controlo Dali. *Dali Lighting control system.*

## encomenda order

Deck + iluminação + acabamento + W + reflector + difusor + opções + extras  
 ex: Deck DS RAL 9005 2x35W mate cristal V K

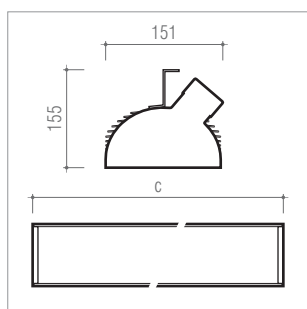

W		(mm) C	G (HF)	V (DIM)	DALI
1x54W	G5	1230	•	•	•
1x80W	G5	1530	•	•	•
2x28W	G5	1230	•	•	•
2x35W	G5	1530	•	•	•
2x49W	G5	1530	•	•	•
2x54W	G5	1230	•	•	•
2x80W	G5	1530	•	•	•
3x54W	G5	1230	•	•	•
3x80W	G5	1530	•	•	•
2x28W + 2x28W	G5	2400	•	•	•
2x35W + 2x35W	G5	3000	•	•	•
2x49W + 2x49W	G5	3000	•	•	•
2x54W + 2x54W	G5	2400	•	•	•
2x80W + 2x80W	G5	3000	•	•	•
4x 2x54W	G5	4800	•	•	•
4x 2x80W	G5	6000	•	•	•

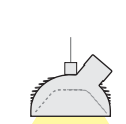
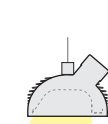
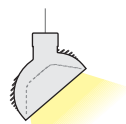
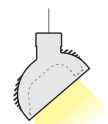
outras versões  
other versionsDeck DS/S  
IP64Deck DA/S  
IP64Deck DS/A  
IP30Deck DA/A  
IP30linhas contínuas  
continuous line

- Cada ponto de electrificação pode ser repicado até 20 lâmpadas.
- Todas as suspensões (localizadas nas extremidades da zona de electrificação) são compostas por um florão (com cabo de alimentação).
- Utilizar cabo de 2,5mm<sup>2</sup> para repicagem.
- Cada projecto de linhas contínuas deverá ser objecto de estudo, consoante a potência das lâmpadas seleccionadas e o comprimento da linha solicitada.
- *Up to 20 lamps from a single supply point.*
- *Junction box with supply cable included in all suspension sets.*
- *Use 2,5mm<sup>2</sup> cable connections on multiple fittings from single supply point feeding.*
- *Each continuous line must be studied according with selected lamp power and line length.*

**!** **Quantidade Mínima** . Os artigos indicados com este símbolo, pressupõem a encomenda de quantidades mínimas. **Minimum Quantity**. Items listed with this symbol, assume a minimum order quantity.



lâmpada não incluída . lamp not included



Marca de conformidade com as Normas Europeias do Comité Europeu de Normalização Electrotécnica (CENELEC), aplicável a todo o material eléctrico certificado pela CERTIF no âmbito do acordo CCA do CENELEC.

*Reference symbol of compliance with the European Norms of the European Electrotechnical Standardization Committee (CENELEC) applied to every electrical material certified by CERTIF in accordance with the CCA of the CENELEC.*



Produto projectado e fabricado em conformidade com a directiva comunitária 89 / 336 / CEE relativa à Compatibilidade Electromagnética e com a Directiva Comunitária 73 / 23 / CEE para equipamento de Baixa Tensão.

*Product designed and manufactured in accordance with the Council Directive 89 / 336 / CEE concerning the Electromagnetic Compatibility and the Council Directive 73 / 23 / CEE for Low-Tension equipment.*



**Classe I**. Isolamento principal e protecção por ligação à terra prevista nas partes metálicas acessíveis.

**Class I**. All the exposed metal parts are connected to one another and to the protective earth conductor.



**Classe III**. Previsto para alimentação em tensão muito baixa.

**Class III**. The luminaire is operated on low voltages supplied by a safety transformer or battery



saliente tecto  
ceiling mounted



suspensa  
suspended



applique parede  
wall mounted



encastrada parede  
wall recessed



de pé  
floor standing



de mesa  
table standing



de canto  
corner mounted



encastrada chão  
floor recessed



encastrada tecto  
ceiling recessed



nº de lâmpadas . potência  
nº of lamps . power



casquilho . lamp holder



dimensões em mm . dimensions in mm



Peso unitário aproximado sem embalagem (em Kg).  
Unit approximate weight without package. Specified in Kg.



Volume unitário com embalagem (em dm³).  
Unit approximate volume with package. Specified in dm³.



**IPxx** **Índice de Protecção**. O primeiro algarismo identifica a protecção à entrada de elementos sólidos e o segundo aos líquidos.

**Ingress Protection**. The first figure being representative of the protection to solid bodies penetration and the second to liquids.



**IKxx** **Índice Resistência Mecânica**. Resistência a impactos mecânicos externos.  
**Mechanical Resistance Classes**. Resistance against external mechanical impacts



**Em Stock** . significa versões dos artigos habitualmente em stock. **In Stock**. versions of articles usually in stock.



**Sob consulta** . upon request.



lâmpada incluída . lamp included



ENEC – Marca comum europeia concedida no âmbito do Acordo ENEC, aplicável a todo o tipo de luminárias em conformidade com as normas da série EN 60 598. Marca reconhecida em todos os países subscritores do referido acordo. 04 – Marca emitida pela CERTIF.

*ENEC – European common reference symbol granted in accordance with the ENEC Agreement, applicable to every type of luminaire within the Standards of the EN 60 598 series. Reference symbol recognized in all the countries that subscribed the referred agreement. 04 – Reference symbol issued by CERTIF.*



Esta luminária não pode ser coberta com material isolante ou análogo. **Luminaire not suitable for covering with thermally insulating material.**



**Classe II**. Com isolamento principal e isolamento suplementar, mas sem meio de protecção por ligação à terra.

**Class II**. The luminaire is insulated in such a way that there are no exposed metal parts that can carry current. There is no protective earth conductor.



**Resistência à chama e à inflamação**. O ensaio é efectuado utilizando um fio de Ni-Cr incandescente aquecido a 650°C, 850°C ou 960°C.



**Resistance to flame and ignition**. The test is made using nickel-chromium glow-wire heated to 650°C, 850°C or 960°C.



dimensão do corte no tecto para encastrar armadura. Tolerância em mm .  
Cut-out dimension for recessed luminaires. Tolerance in mm



adaptável aos módulos standard dos tectos falsos .  
adaptable to the standard modules of the false ceilings



distância mínima dos objectos iluminados (em metros) .  
minimum distance between the lit object and the luminaire (in metres)



**Substituição por Lâmpada de LED's**. Este símbolo, presente junto de alguns dos produtos, significa que é possível a substituição de lâmpadas vulgares (incandescentes, halógeno, etc..) por lâmpadas de LED's adaptáveis (com as mesmas características, mesmo suporte).

**LED replacement Lamps**. This symbol next to some of our products indicates that it is possible to replace traditional pin base or screw base bulbs such as incandescent, halogen, etc ... by replacement LED lamps (maintaining the same lampholder and general characteristics).