



descrição description

- Uplight disponível com LED cor branca, vermelha, azul, verde ou âmbar.
- Luz difusa e a homogeneidade da cor para liberdade de criação no design de interiores.
- Fabricado em alumínio com vidro de protecção e driver incluído (350mA-230V).
- Elevado índice de protecção (IP 66 e IK06) permitindo múltiplas utilizações, quer em interiores, quer em exteriores.
- Com extensão de 5m em cabo reforçado, apropriada para circuitos de alimentação em exterior.
- LED uplight (available in white, red, blue, green or amber colour).
- Uniform colour and diffused light intended for creative room design intervention.
- Frame made of aluminium with glass protection cover and power unit included (350mA-230V).
- High degree of protection (IP66 and IK06) for multiple potential applications, indoor or outdoor.
- 5m reinforced feed cable supplied for exterior power supply.



pormenores details

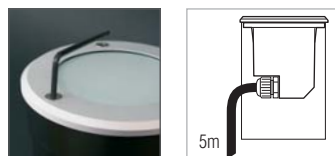









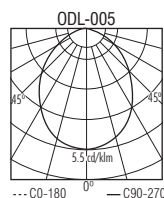

Nota: é necessária aplicação prévia do corpo exterior que deverá ficar encastrado e envolvido no próprio pavimento.
 Note: External casing must be previously recessed at the concrete floor.
 Incluída extensão de 5m em cabo reforçado com cobertura de borracha (H07RN-F), apropriado para circuitos de alimentação em exteriores, incluindo situações de imersão total.
 The 5m reinforced feed cable supplied is approved (H07RN-F) for exterior power supply including total immersion situations.

acabamento finishing

- 06 Aro em alumínio com acabamento Cinza alumínio RAL 9006 . Frame in aluminium with Grey-coated RAL 9006 finish.

diagr.polar p.diagr.











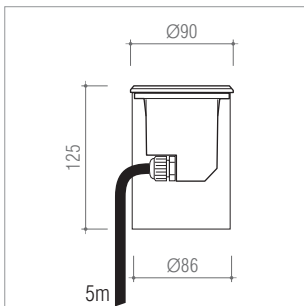

simbologia symbols ·    |  230V/50Hz (350mA) EN 60 598    960°C IP66  IK06 340Kg/cm² 

difusores diffusers ·  Vidro Fosco / Frosted Glass

encomenda order ·

ex: ODL-005 - BL = 32.82.001.01.10



W		(32.82. ...)					
1x1W	LED		001.01.12	001.01.09	001.01.11	001.01.10	•
							
					0.636	1,4	±1 (mm) Ø87 / h=120

exemplos examples ·



! **Quantidade Mínima** . Os artigos indicados com este símbolo, pressupõem a encomenda de quantidades mínimas. **Minimum Quantity**. Items listed with this symbol, assume a minimum order quantity.



lâmpada não incluída . lamp not included



Marca de conformidade com as Normas Europeias do Comité Europeu de Normalização Electrotécnica (CENELEC), aplicável a todo o material eléctrico certificado pela CERTIF no âmbito do acordo CCA do CENELEC.

Reference symbol of compliance with the European Norms of the European Electrotechnical Standardization Committee (CENELEC) applied to every electrical material certified by CERTIF in accordance with the CCA of the CENELEC.



Produto projectado e fabricado em conformidade com a directiva comunitária 89 / 336 / CEE relativa à Compatibilidade Electromagnética e com a Directiva Comunitária 73 / 23 / CEE para equipamento de Baixa Tensão.

Product designed and manufactured in accordance with the Council Directive 89 / 336 / CEE concerning the Electromagnetic Compatibility and the Council Directive 73 / 23 / CEE for Low-Tension equipment.



Classe I. Isolamento principal e protecção por ligação à terra prevista nas partes metálicas acessíveis.

Class I. All the exposed metal parts are connected to one another and to the protective earth conductor.



Classe III. Previsto para alimentação em tensão muito baixa.

Class III. The luminaire is operated on low voltages supplied by a safety transformer or battery



saliente tecto
ceiling mounted



suspensa
suspended



applique parede
wall mounted



encastrada parede
wall recessed



nº de lâmpadas . potência
nº of lamps . power



casquilho . lamp holder



dimensões em mm . dimensions in mm



Peso unitário aproximado sem embalagem (em Kg).
Unit approximate weight without package. Specified in Kg.



Volume unitário com embalagem (em dm³).
Unit approximate volume with package. Specified in dm³.



IPxx **Índice de Protecção**. O primeiro algarismo identifica a protecção à entrada de elementos sólidos e o segundo aos líquidos.

Ingress Protection. The first figure being representative of the protection to solid bodies penetration and the second to liquids.



IKxx **Índice Resistência Mecânica**. Resistência a impactos mecânicos externos.
Mechanical Resistance Classes. Resistance against external mechanical impacts



Em Stock . significa versões dos artigos habitualmente em stock. **In Stock**. versions of articles usually in stock.



Sob consulta . upon request.



lâmpada incluída . lamp included



ENEC – Marca comum europeia concedida no âmbito do Acordo ENEC, aplicável a todo o tipo de luminárias em conformidade com as normas da série EN 60 598. Marca reconhecida em todos os países subscritores do referido acordo. 04 – Marca emitida pela CERTIF.

ENEC – European common reference symbol granted in accordance with the ENEC Agreement, applicable to every type of luminaire within the Standards of the EN 60 598 series. Reference symbol recognized in all the countries that subscribed the referred agreement. 04 – Reference symbol issued by CERTIF.



Esta luminária não pode ser coberta com material isolante ou análogo. **Luminaire not suitable for covering with thermally insulating material.**



Classe II. Com isolamento principal e isolamento suplementar, mas sem meio de protecção por ligação à terra.

Class II. The luminaire is insulated in such a way that there are no exposed metal parts that can carry current. There is no protective earth conductor.



de canto
corner mounted



de pé
floor standing



encastrada chão
floor recessed



de mesa
table standing



encastrada tecto
ceiling recessed



650°C **Resistência à chama e à inflamação**. O ensaio é efectuado utilizando um fio de Ni-Cr incandescente aquecido a 650°C, 850°C ou 960°C.



850°C **Resistance to flame and ignition**. The test is made using nickel-chromium glow-wire heated to 650°C, 850°C or 960°C.



960°C



dimensão do corte no tecto para encastrar armadura. Tolerância em mm .



Cut-out dimension for recessed luminaires. Tolerance in mm



adaptável aos módulos standard dos tectos falsos .
adaptable to the standard modules of the false ceilings



distância mínima dos objectos iluminados (em metros) .
minimum distance between the lit object and the luminaire (in metres)



Substituição por Lâmpada de LED's. Este símbolo, presente junto de alguns dos produtos, significa que é possível a substituição de lâmpadas vulgares (incandescentes, halógeno, etc..) por lâmpadas de LED's adaptáveis (com as mesmas características, mesmo suporte).

LED replacement Lamps. This symbol next to some of our products indicates that it is possible to replace traditional pin base or screw base bulbs such as incandescent, halogen, etc ... by replacement LED lamps (maintaining the same lampholder and general characteristics).